

Azo-Core™

thermal barrier

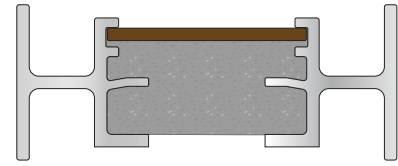

Code breaker for thermal barrier fenestration performance



Azon Saves Energy

high performance total design concept from the **AZO/Tec®** team



Azo-Core™ thermal barrier

A design concept from the AZO/Tec® design department influenced by European technology, Azo-Core™ adapts the time-proven use of polyurethane foam as its thermal barrier insulator for aluminum fenestration.

Azo-Core™ is a unique high-density foam strengthened by MLP™ (mechanical lock profile) the exclusive Azon system for ensuring integrity of the strength and adhesion of the foam to difficult-to-adhere-to finishes. Azo-Core is provided under the Azon warranty umbrella—the only protection of its kind for aluminum fenestration in the world.

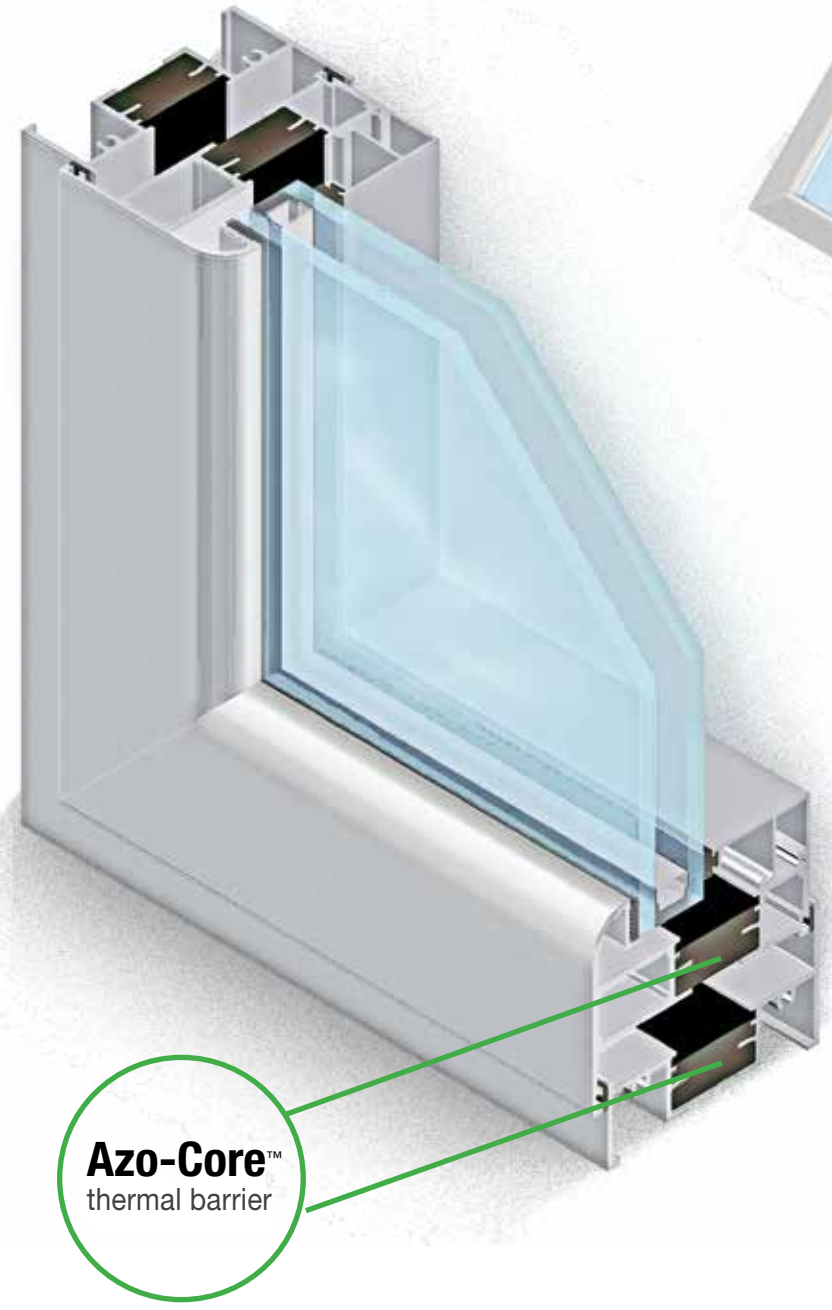

Processing: How it works

Azo-Core™ thermal barrier

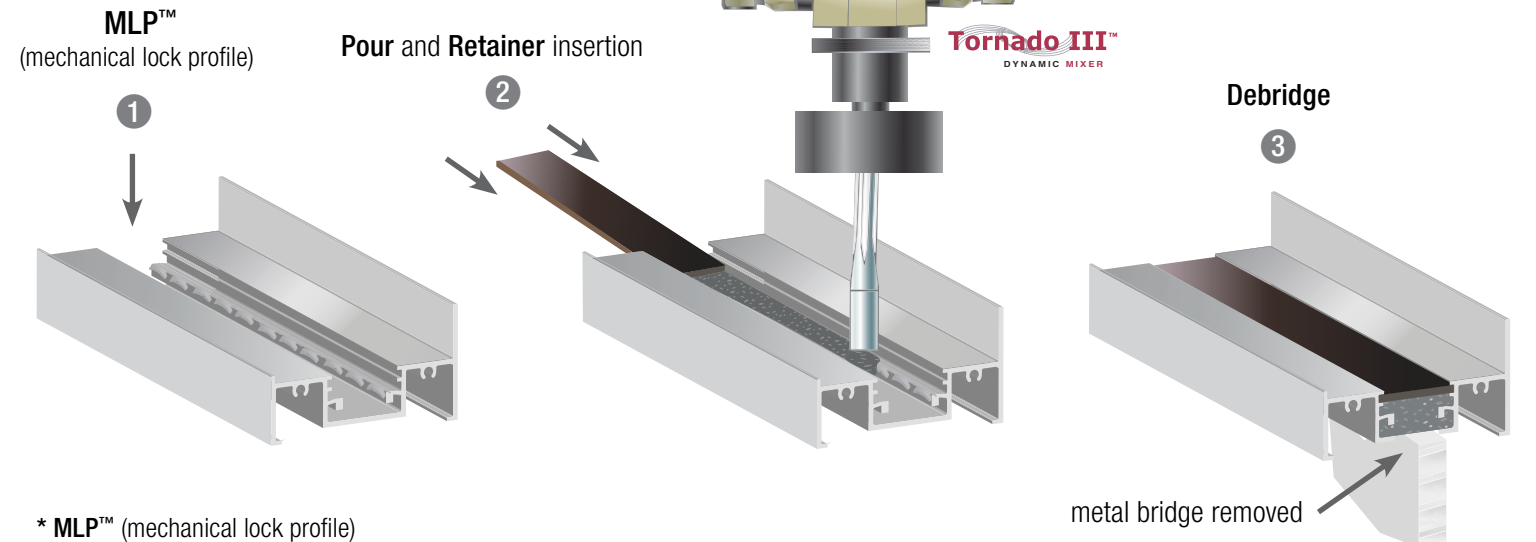

* MLP™ (mechanical lock profile)

Azo-Core™ energy efficient design with mechanical locks: Participants in the Approved Azo-Brader™ Applicator and Lancer™ programs qualify for the Azon 10-year warranty against failure of the thermal barrier core due to dry shrinkage and fracturing.

Thermal properties

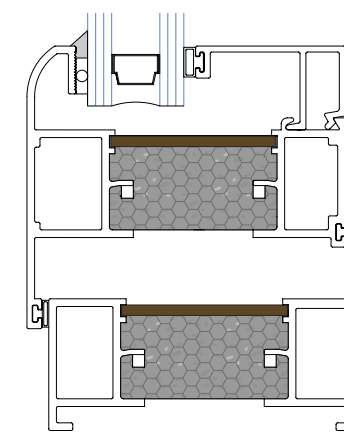
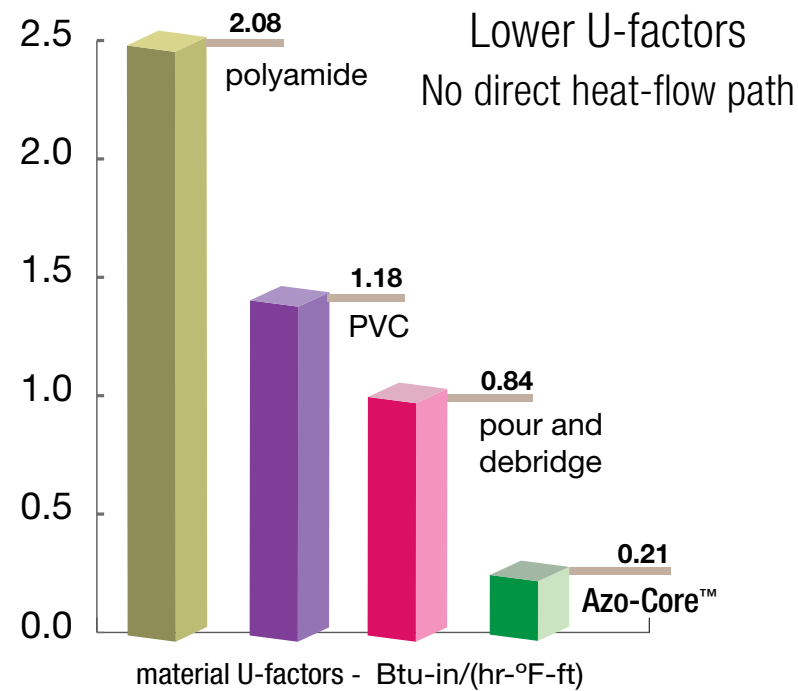

Series 32 mm Azo-Core™

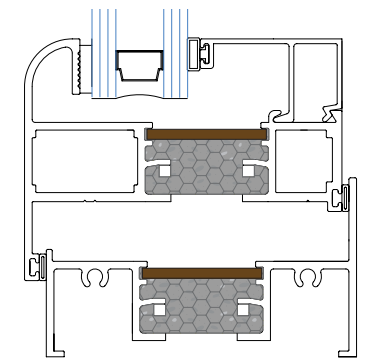

Series 19 mm Azo-Core™

Glass	U cog	U-factor	Glass	U cog	U-factor
Glass - 1 inch, double insulating			Glass - 1 inch, double insulating		
low E / argon / clear	0.25	0.29	low E / argon / clear	0.25	0.39
Glass - 1-3/4 inch, triple insulating			Glass - 1-3/4 inch, triple insulating		
low E / argon / clear / argon / low E	0.12	0.20	low E / argon / clear / argon / low E	0.12	0.29

Azon thermal barrier technology | windows storefront curtain wall

Intelligent technology for fenestration systems that require superior thermal and structural performance

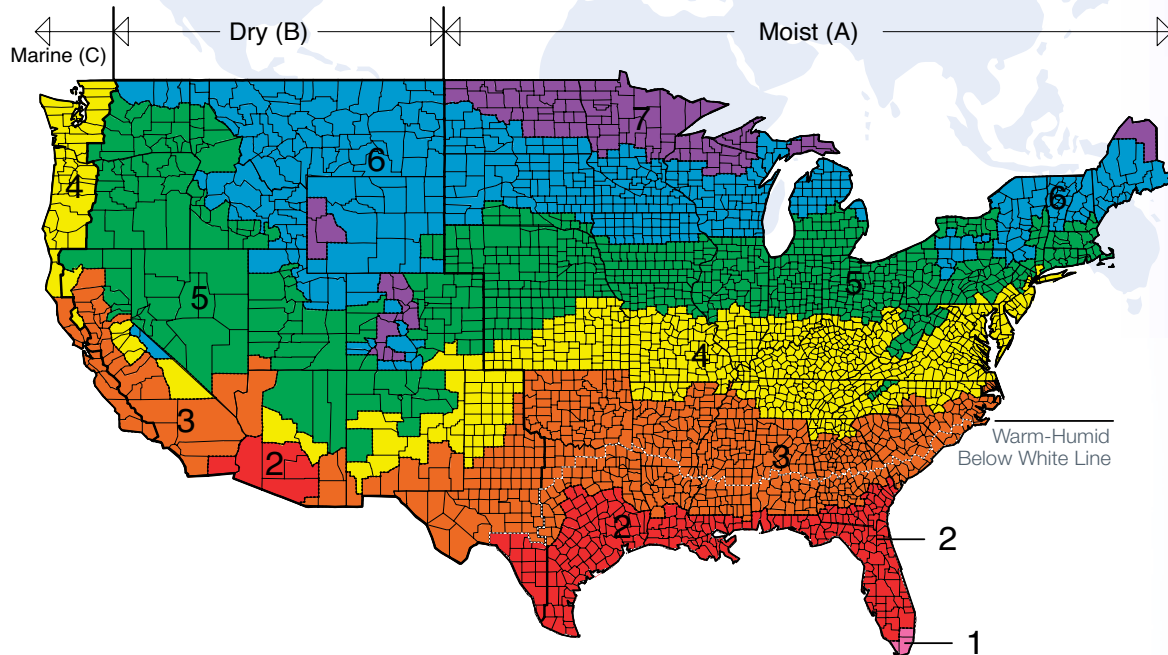

All of Alaska in Zone 7 except for some Boroughs in Zone 8
Zone 1 includes Hawaii, Guam, Puerto Rico, and the Virgin Islands

Azo-Core™ offers higher performance options, thermal insulation and strength that meet or exceed all published codes from Miami to Minneapolis—more than any other system in the world!



Azon
643 W. Crosstown Parkway
Kalamazoo, MI 49008-1910
USA
Tel: 269 385 5942
Fax: 269 373 9295

www.azonintl.com

Azon UK Ltd.
Unit J, St. David's Industrial Estate
Pengam, Blackwood
NP12 3SW
UK
Tel: +44 (0) 1443 878010

Azon Korea Inc.
E1-Space
19 Samseong 122 St.
Gangnam, Seoul 06085
Korea
Tel: +82 (0) 2 34492200
Fax: +82 (0) 2 34492229

Azon Polyurethane (Shanghai) Co., Ltd.
Room 2804-2807, 28th Floor
Hua Yuan World Square
1958 North Zhongshan Road
Shanghai 200063
PR China
Tel: + 86 (0) 21 6212 2213
Fax: + 86 (0) 21 6211 0004

AZO/Tec®
Interdisciplinary team of designers, simulation services and testing



©Azon 2016 TBFOLD017